

SCOTTISH SCHOOLS SCIENCE

EQUIPMENT RESEARCH

CENTRE

Bulletin No. 105.

June, 1978.

# Contents

Introduction	- cost index	Page 1.
	- surplus equipment ballot	1.
	- overseas subscriptions	1.
Physics Notes	- surplus equipment	1.
Chemistry Notes	- redox prediction analogue	4.
Biology Notes	- a thorax bell-jar model	7.
Trade News		9.
In the Workshop	- redox prediction analogue	10.
Address List		12.

# Introduction

Our cost index of items of consumable apparatus. (=100 in May, 1974) was calculated afresh in mid-May and found to be 188.9. This is an increase of 11.5% over the whole year, and 7.5% since the index was previously calculated in November, 1977.

\* \* \* \* \*

Despite our bad timing, which means that most schools will be on holiday when it happens, the ballot for the surplus equipment listed in the Physics Notes section of this bulletin will be held as usual, in the manner indicated in Bulletin 91. However, we will not notify those who have been successful until the end of August. This should not deter anyone from phoning us to find if they have got anything, nor from coming to collect it. We would remind all our customers that the onus of collection is on them. This is done because postal or freight charges are now so heavy (often they amount to more than the cost of the goods themselves) that any other possible method of moving the goods is to be preferred. Anyone who has been allocated items in the ballot is expected to notify us if he wishes the goods posted or freighted to the school. This we will certainly do, and any transport charges will be added to the bill. In the absence of any such notification the items will remain in the Centre awaiting collection. We would also remind readers that although the Centre is open during normal hours in the holiday period, there will be no Saturday morning openings from 1st July to 19th August, both dates inclusive.

\* \* \* \* \*

Our foreign readers are hereby reminded that they are required to remit £1 (one pound) by cheque, international postal order or other means, if they wish to receive our bulletins for session 1978/79. No further notice will be issued, nor is it necessary to notify us if you wish to stop supplies reaching you - this will happen automatically if the subscription is not paid within a reasonable time. Neither can we submit invoices directly to the reader, or deal through subscription agencies unless they have been instructed to remit the subscription in the above manner and do so. It will be obvious that the £1 barely covers the cost of posting bulletins overseas and so we do not feel justified in incurring the administrative expense of raising invoices etc. In blunt terms, if the overseas reader cannot reclaim this sum after he has paid it, from any institutional funds to which he has access, and if he is unwilling to pay such a trifling amount from his own pocket, he must do without.

## Physics Notes

The following items of surplus equipment are offered for sale. Items up to No. 835 are old stock and are not subject to the ballot. Items from No. 851 onwards will be subject to the ballot procedure described in Bulletin 91. We would also direct customers to the observations regarding payment on page 1

of Bulletin 103.

- Item 660. (Bulletin 89) Hour meter, £1.50  
Item 665. ( " ) Large micro-ammeter, £3.  
Item 684. (Bulletin 91) McLeod gauge, £10.  
Item 701. ( " ) Electrolytic capacitors, 2p.  
Item 704. ( " ) Toggle switch, 5p.  
Item 707. ( " ) Power diode, 1p.  
Item 716. ( " ) Hydroquinone, 50p.  
Item 718. ( " ) Developer, 20p.  
Item 741. (Bulletin 97) Fixer, 10p.  
Item 751. ( " ) Oscilloscope, £15.  
Item 752. ( " ) Power supply, £2.  
Item 753. ( " ) Power supply, £1.  
Item 756. ( " ) Video oscillator, £10.  
Item 762. ( " ) Titling unit, 50p.  
Item 764. ( " ) Meter chassis, £3.  
Item 767. ( " ) Meter chassis, £1.50.  
Item 768. ( " ) Control unit, £2.  
Item 784. ( " ) Display panel, 50p.  
Item 787. (Bulletin 100) Relay test set, £4.  
Item 788. ( " ) Test set, £4.  
Item 789. ( " ) Low voltage variac, £1.  
Item 790. ( " ) Valve voltmeter, £5.  
Item 795. ( " ) Scaling unit, £5.  
Item 800. ( " ) Sodium lamp, 20p.  
Item 811. ( " ) Hypam fixer, 35p.  
Item 822. (Bulletin 101) Flat bottom flask, 45p.  
Item 825. ( " ) Evaporating basin, 38p.  
Item 827. ( " ) Separating funnel, £3  
Item 829. ( " ) Filter paper, 10p.  
Item 831. ( " ) Meopta microscope, £25.  
Item 832. ( " ) Meopta microscope, £17.50.  
Item 835. ( " ) Microscope lamp, £12.  
Item 851. (3) Teltron TEL 523 Maltese cross tube, £11.  
Item 852. (3) Teltron TEL 524 Perrin tube, £11.  
Item 853. (4) Teltron TEL 525 deflection e/m tube, £16.  
The above items are new but sub-standard tubes with small blemishes and all are in working order.  
Item 854. (6) Searle's conductivity apparatus, W.B. Nicolson cat. 30/1515, £4.  
Item 855. (5) Universal interference apparatus, Griffin and George cat. XFX-500-J, £5.

- Item 856. (1) Pump plate, new, 17.5cm diameter, Griffin and George cat. PXW-290-Q, £30.
- Item 857. (1) Newton's rings apparatus, new, Griffin and George cat. XFX-400-R, £5.
- Item 858. (4) Clement and Desormes' apparatus, Griffin and George cat. XHS-320-Q, £2.
- Item 859. (1) Chain dial balance, 500g x 5mg, similar to Griffin and George BEW-360 but with different case, £10.
- Item 860. (1) Electric fields apparatus, Philip Harris cat. P50310/7, £2.
- Item 861. (5) Gold leaf electroscope, Philip Harris cat. P51150/5 with top plate electrode only, £4.
- Item 862. (12) Permanent magnet; field strength is more than three times that of the Eclipse Major, but the gap is smaller, 20mm diameter x 16mm wide, £3.
- Item 863. (2) Compression spring balance by Salter; with spirit level indication. Scales 0 - 22lb x 1oz and 0 - 10kg x 20g; oval scale pan 28 x 40cm, £6.
- Item 864. (5) Stopwatch, main scale 0 - 1 x 0.01 min, auxiliary scale 0 - 60 x 1min; this watch ticks at 0.2s intervals, £2.
- Item 865. (19) Ditto 0 - 30 x 0.1s main scale, 0 - 15 x 0.5 min, auxiliary scale, £3.
- Item 866. (3) Ditto, 0 - 30 x 0.1s main scale, 0 - 15 x 0.5 min auxiliary scale, £3.
- Item 867. (3) Typewriter, manual, £3.
- Item 868. (2) Typewriter, electric, £5.
- Item 869. (9) Ex-equipment cooling fans for 230V a.c. working, enclosed in metal grill 13 x 14 x 9cm, £2.
- Item 870. (16) Electric motor, 0.035 h.p., dual speed 1350/1650 rev/min with toothed belt, cooling fan and mains suppressor, £2.
- Item 871. (18) Mains motor, gramophone type, 2800 rev/min with belt drive to 12 x 47mm shaft giving 2:1 reduction, £1.
- Item 872. (15) Small 115V mains motor in a variety of speeds 30 - 180 rev/min, 50p.
- Item 873. (4) Hysteresis motors for 115V mains but supplied with suitable dropper resistor for use on 240V, speeds in the range 1 - 4 rev/h., 50p.
- Item 874. (6) Photographic film, Ilford FP4 120 roll, 40p.
- Item 875. (170) Photographic film, Kodak TXP120 roll, 35p.
- Item 876. (200+) Photographic paper, Kodak WSG1S soft, 5½ x 5½in, box of 100 sheets, 75p.
- Item 877. (3) As above but 8 x 10in size, £2.
- Item 878. (2) As above but 12 x 15in size, £4.
- Item 879. (1) As above, WSG2S normal, 8 x 10in size, £2.

- Item 880. (1) As above but 12 x 15in size, £4.  
Item 881. (9) As above WSG3S hard, 8 x 10in size, £2.  
Item 882. (1) As above WSG4S extra hard, 12 x 15in size, £4.  
Item 883. (1) As above WFL2D, Bromesko normal, 16 x 20in, box of 100 sheets, £6.  
Item 884. (3) As above but packs of 25 sheets, £1.50.  
Item 885. (12) As above WFL3D hard, 12 x 15in, pack of 25 sheets, £1.  
Item 886. (6) As above but 16 x 20in size, £1.50.  
Item 887. (13) Photographic paper Kodak Veribrom (resin coated) WSG1M,  $4\frac{1}{2}$  x  $6\frac{1}{2}$ in, box of 100 sheets, £1.  
Item 888. (2) As above but 8 x 10in size, £3.  
Item 889. (8) As above, 12 x 15in size, £5.  
Item 890. (60) Sodium hydroxide pellets, photographic grade by M and B, 500g, 30p.  
Item 891. (18) Planetol (metol) by M and B, 500g, 50p.  
Item 892. (8) D19 high contrast developer, in tins, to make 4.5l solution, 50p.  
Item 893. (8) MQ developer in tins; tin contains 12 packets, each of which will make 450ml solution, 30p  
Item 894. (8) Sodium wire in paraffin, approx. 50g, 10p.  
Item 895. (2) Insulation tester, 500V megger, £5.  
Item 896. (1) Electronic desk calculator, Canola 161S, four function and memory, 16 digit display, £5.  
Item 897. (9) Dry battery, 6V bell type, 20p.

## Chemistry Notes

Use of redox potentials and prediction of direction of spontaneous reactions causes difficulty for some pupils. Furthermore the fact that redox pairs "above" hydrogen have negative potentials and those "below" it have positive potentials tends to give some the impression that one group is electropositive, the second group electronegative and that hydrogen is strangely "electrically neutral!" This analogue balance can offer some help in this situation.

Each redox pair is represented by a wooden block with a hole for attaching it to the beam of a simple balance and is suitably weighted by either putting lead into holes drilled in the bottom or by sawing off small amounts of the wood. The magnitude of the potential as a redox pair is represented by the weight of the block. Some samples are shown below.

The oxidised form is depicted on the top of each redox pair block and the reduced form on the lower half. Pupils can easily 'feel' the 'strength' of each oxidised form.

$\overset{\circ}{\text{Zn}}^{2+}$	$\overset{\circ}{\text{H}}^{+}$	$\overset{\circ}{\text{Fe}}^{3+}$	$\overset{\circ}{\text{Br}}_2$	oxidised form
$\text{Zn}$	$\text{H}_2$	$\text{Fe}^{2+}$	$\text{Br}^{-}$	reduced form
-0.76V	0.00V	+0.77V	+1.09V	

To test a reaction, two selected blocks representing possible starting materials are hung one on either side of the balance beam. The beam is behind the support and so not visible from the front. The blocks are also behind the support so that when the beam tilts one way or the other, the products of the reaction appear in two diagonally opposite corners of the support, where these corners have been cut away. A clear perspex tube attached to the pivot of the beam tilts with it, and a ball inside the tube rolls in the direction of the electron flow. Thus we have a simple means of predicting whether a reaction can or cannot proceed under standard conditions. In addition, we can attach a tension spring balance to the heavier limb of the beam balance and by pulling it up until the beam is level, the spring balance reading will show the potential difference generated by the two redox pairs.

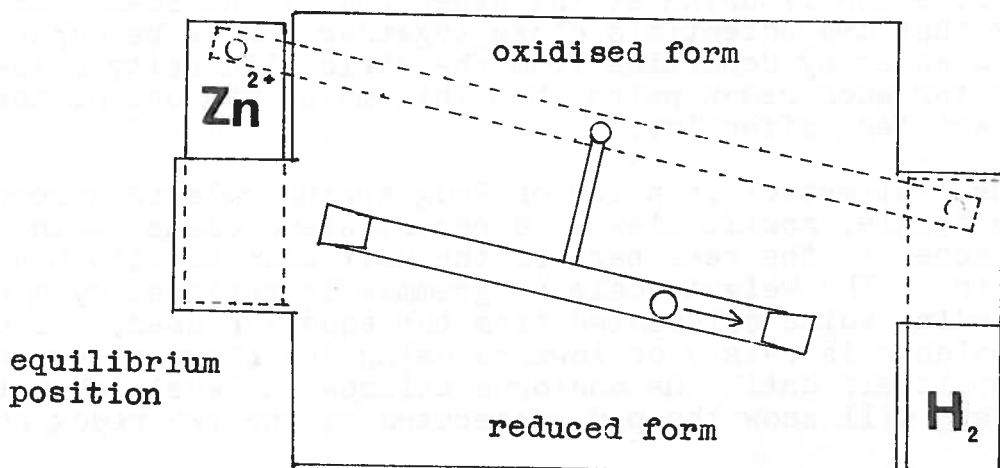
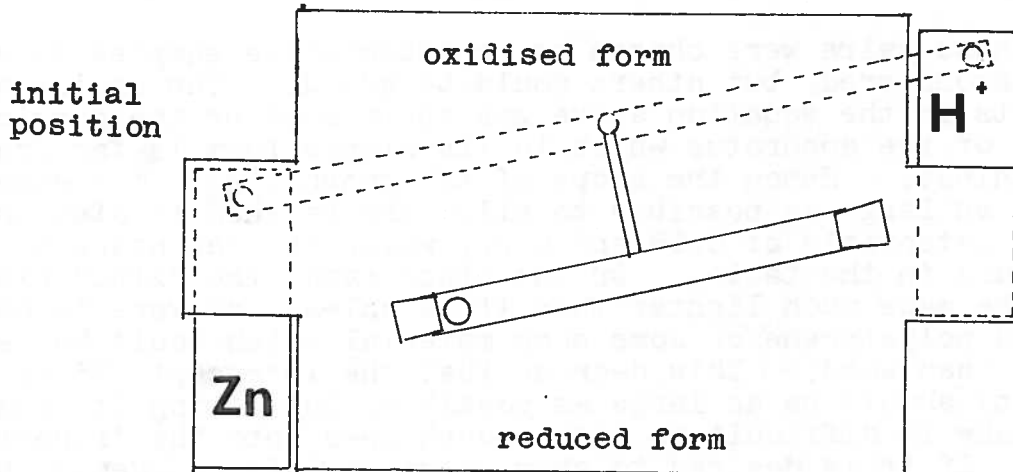

The relationship between the mass  $m$  in grammes of a block and the potential  $V$  in volts which it represents is given by the equation

$$m = 62V + 85.$$

This results in the following values for the redox pairs.

Redox pair	Standard redox potential, (V)	Mass (g)
$Zn^{2+}/Zn$	- 0.76	38
$H^+/H_2$	0.00	85
$Cu^{2+}/Cu$	+ 0.34	106
$I_2/I^-$	+ 0.54	118
$O_2/H_2O_2$	+ 0.68	127
$Fe^{3+}/Fe^{2+}$	+ 0.77	133
$Br_2/Br^-$	+ 1.09	153
$Cl_2/Cl^-$	+ 1.36	169
$H_2O_2/H_2O + O_2$	+ 1.77	195
$F_2/F^-$	+ 2.85	262

These pairs were chosen as representative samples likely to be encountered, but others could be added. The choice of constants in the equation above was restricted by the physical demands of the apparatus which in its simple form is far from frictionless. Hence the slope of the graph (62 in the equation) must be as large as possible to allow the balance to distinguish between potentials of 0.68 and 0.77, which are the nearest neighbours in the table. On the other hand, the "zinc" block cannot be made much lighter than it is unless one were to use expanded polystyrene or some such material which would be less durable than wood. This decrees that the intercept (85 in the equation) should be as large as possible, but making it bigger would make it difficult to pack enough lead into the "fluorine" block. If it is desired to show weaker oxidising agents than  $Zn^{2+}$  (i.e. stronger reducing agents than Zn) then one may have to sacrifice the fluorine at the other end of the scale, or run the risk that two potentials close together cannot be separated. One could cheat by departing from the strict linearity relationship for such redox pairs, but this makes the use of the 'voltmeter' less effective.

The 'voltmeter' is a 200 or 250g spring balance suspended from the single, mobile claw of a retort stand clamp, with its hook attached to the rear part of the bolt used to attach a redox pair. The weight scale of grammes is replaced by a paper scale reading volts calculated from the equation used. The spring balance is raised or lowered using the clamp screw and/or the clamp itself until the analogue balance is level, when the 'voltmeter' will show the p.d. generated by the two redox pairs.



## Biology Notes

Almost every teacher of biology will be familiar with the now traditional bell jar model of the thorax. One recurring problem with this model is the perishing of the rubber sheet used to represent the diaphragm which therefore has to be periodically replaced. With the advent of more or less inelastic 'plastic' substitutes for rubber sheeting it is becoming more difficult to find suitable diaphragm material at reasonable cost. Griffin and George sell a material, catalogue number YUH-390-520L which costs £1.65 for 30 x 30cm but this is sufficient for only one diaphragm (the normal use for this sheet is as a plant pot cover in potometry). We have tried polythene and other plastic materials and although they worked, none were really very satisfactory.

We were therefore very interested in a suggestion from a school, that we try using material from an old inner tube. Suitable inner tubes are often to be had for the asking from garages and tyre fitting bays. The larger sizes from vans and lorries should be avoided since they tend to be too thick. Tubes for small cars such as the one we used from a Mini are easier to handle.

The sequence of operations needed to fit the diaphragm is shown below. The only tools needed are a pair of stout scissors, a 'Stanley' knife, a screwdriver and possibly a Schroeder valve extractor. The Schroeder valve is depressed or removed and the tube fully deflated. It is then laid on the bench and two cuts made as shown in Fig. 1 along the lines marked AA and BB.

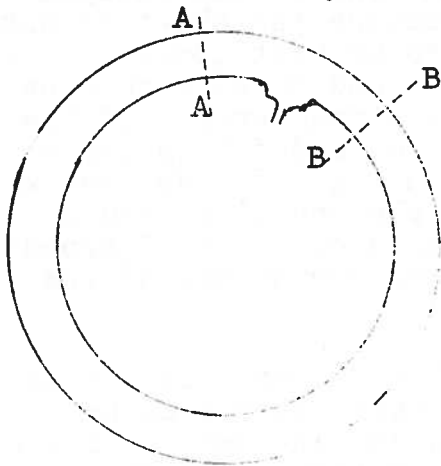

Fig. 1.

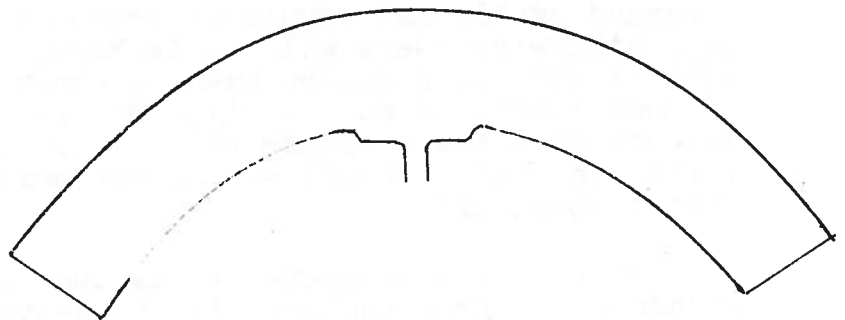

Fig. 2.

The segment so removed is then cut along its length as shown in Fig. 2. This section can then be opened out. However because it has formed part of a tube, it will not lie completely flat and this causes most of the complications in the subsequent steps of the procedure. The bell jar is placed on the inside surface of the opened out tube with the valve in the centre and drawn round with a marker pen. This line is used as a guide for making the next cut. Because the rubber will not

be a regular circle and because an overlap is required to give a seal at the bottom lip of the bell jar and to provide a means of attachment to the jar, a second, concentric, circle should be marked out with a diameter at least 70mm greater than that of the bell jar. The rubber is then cut round this line. (Fig.3).

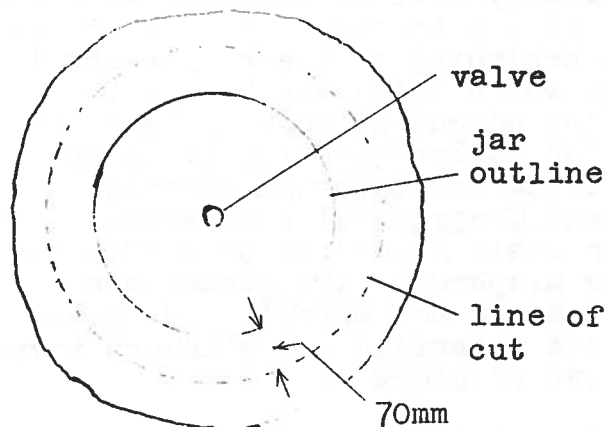

Fig. 3.

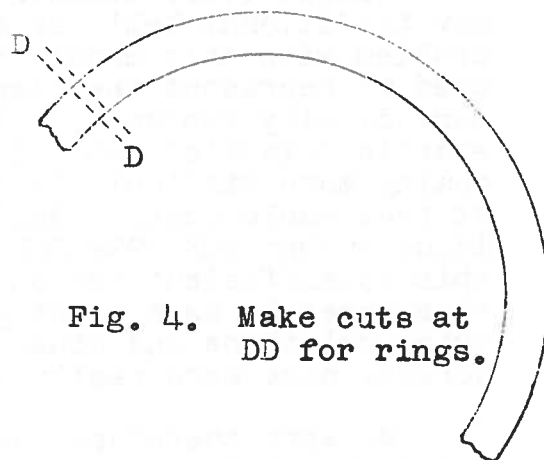

Fig. 4. Make cuts at DD for rings.

Rings or rubber are then cut from the remainder of the tube (Fig. 4) to hold the diaphragm onto the bell jar and to protect the edges of the diaphragm against being cut by the jubilee clip. Make cuts at points marked DD to form rings.

The most difficult part of the operation now follows and requires the co-operation of two or three 'operatives'. The bell jar is held bottom upmost and the rubber stretched over the bottom. A smear of grease over the lip over the jar helps prevent leaks but does cause the rubber to slide about. The rubber is held stretched over the base of the jar while one or two rubber rings, cut as shown in Fig. 4, are slipped over to hold it. This can be tricky because the sheet is not completely flat and the valve stem has to be kept central. Inevitably there will be a number of pleats and these should be arranged neatly and regularly around the circumference of the jar, otherwise there will be leakage. For added security a jubilee type clip can be used as shown in Fig. 5. We used a 78-89mm 'Terry' security clip but obviously the size needed depends upon the circumference of the jar used. The Schroeder valve can then be replaced and any surplus rubber beyond the clip trimmed off.

It was also suggested to us that it would be possible to withdraw air from the jar via the valve stem using a large syringe and syringe valve, or by using a vacuum pump. If the bell jar is partially evacuated then the balloons inflate slightly and, more importantly, the relaxed diaphragm will assume its correct domed shape. We have tried this out and it does work, although some difficulties were encountered. If the pressure is lowered sufficiently to dome the diaphragm then pulling on the valve to 'contract' the diaphragm against the pressure difference is hard work. In addition, any tendency for the apparatus to leak is accentuated. The safety conscious might want a screen between them and the apparatus to guard against the consequences of implosion, but if the pressure difference were large enough to cause significant risk, it would probably prove impossible to flatten the diaphragm at all. For example, the thrust on the diaphragm of a 17.5cm diameter bell jar when totally evacuated is greater

than any work weight-lifting record.

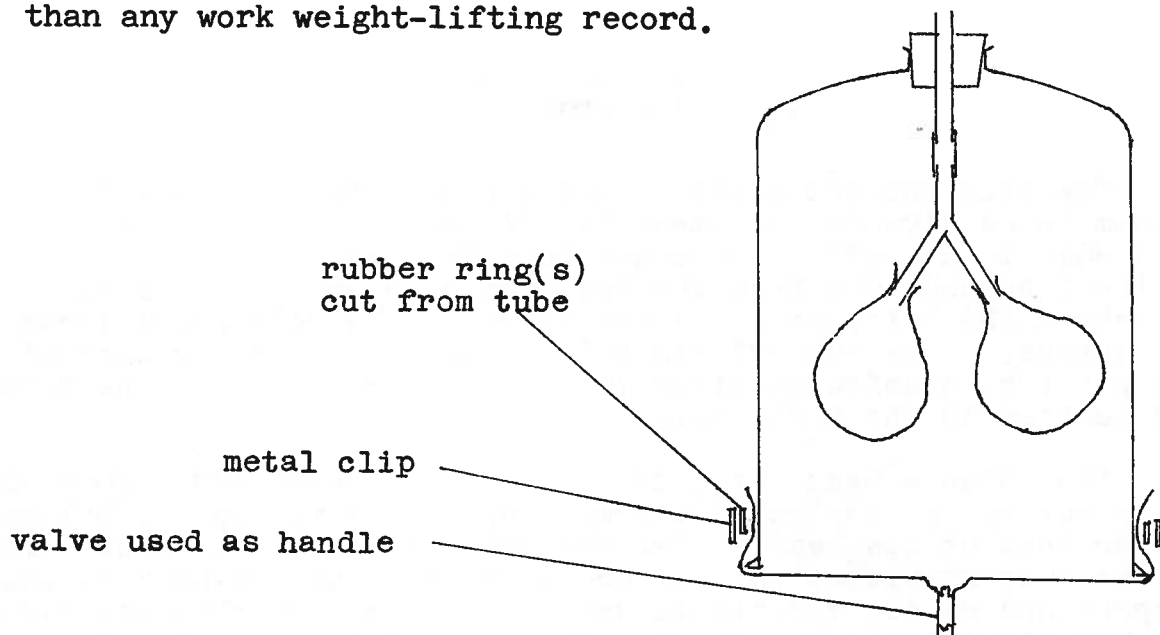

Philip Harris have established a new office in East Kilbride, discontinuing their warehouse facility. All Scottish orders should be sent to the new address, which will be found on page 12 of this bulletin.

We have tested a new ceramic centred wire gauze, made by Refracpac. The gauze measures 130 x 130mm and has a ceramic centre 105mm diameter. It has stood up well to our intensive short-term tests, and at 25p each with discounts for quantity it seems very good value. We do wish that someone would find us a satisfactory alternative to asbestos tape.

An equipment tester, Cat. No. EA799 from Irwin-Desman costs £75. A mains 13A socket is provided to which the equipment is plugged in, and the instrument tests the insulation between mains and earth at 1000V. A croc. clip lead attached to any metal framework on the equipment is used to test the security of the earthing of the framework by passing a heavy current through it. We believe that the regional educational authorities should have a sufficient number of these testers to allow all portable mains operated equipment in a school (not just items in the science department) to be tested at least once a year, for example during the summer vacation. Our own experience shows that soldering irons are most often at fault, with newly bought ones failing the insulation test.

When a piece of equipment fails one of the tests described above, what does the teacher or technician do about it? Failing a repair service in the region, one answer would be to send it to Control System Services. This is a calibration and repair organisation for most types of electronic instruments, including obsolete models which are no longer supported by the manufacturer. The only equipment they will not service are small bench meters and suspension galvanometers, or any item which constitutes an uneconomical repair. The firm's concern with schools equipment can be gauged from their having a former physics teacher as education adviser.

## In The Workshop

The back support plate of the analogue balance is made of 6mm thick plywood, and measures 375 x 230mm. A piece 50 x 80mm is cut off each corner (see Fig. 1). Along the centre line and 70mm from the top a hole is drilled in a size to make a 2BA bolt, which is the pivot of the balance, a loose fit inside. The support plate is reinforced in the region of the pivot by a softwood block 140 x 40 x 19mm glued to the back and centred on the pivot hole.

The balance beam (Fig. 2) is a piece of wood 370 x 20 x 5mm. The pivot in its centre is a 50mm long 2BA bolt, tightly bolted to the beam at its head. Two washers are placed at either side of the support plate, the balance beam being at the back of the support and so not visible in use. Two similar bolts are fixed, mid-way along their length at either end of the beam to hold the redox pair blocks.

The front of the pivot at the front of the support plate is secured by a locknut, and forward of this is fixed another nut which has brazed to it a 30mm long 4BA bolt. The other end of this bolt is tapped into a perspex tube, 18cm long, and 13mm inside diameter. A 10mm diameter polystyrene ball is put in the tube which is then closed at each end by two No. 13 solid rubber lungs.

The redox pair blocks are pieces of chipboard measuring 140 x 47 x 18mm - these have a mass of about 64g. Hence for the zinc pair, multiple saw-cuts have to be made in the rear face of the block to remove enough to bring this down to 38g. This should be done only after the locating hole on which the block is hung on the balance has been taken out. The hole should be large enough to allow the block to tilt freely on the 2BA bolt. For the other substances, the blocks require to be weighted with lead in the form of plugs fitting into one or more holes drilled upwards from the bottom of the block. A suitable source of lead plugs, if you can find it, is old piano keys, each of which is weighted with one such plug. Alternatively one can pour molten lead into the holes, although this is a less accurate technique and will need more adjustment to get the correct weight. In either case it is better to err on the heavy side and then take out the excess with shallow saw-cuts in the block. Our blocks were rectangular in form but with hindsight we should have cut off the two top corners, or rounded them off, as this makes it easier to hang the blocks on the beam. This would need to be done before adjusting the individual weights. Fig. 3 shows this part of the construction.

The top half of each block is painted pink, the lower half light blue, with the information in black ink. The support plate is painted white; the labels 'oxidised form' and 'reduced form' in Fig. 1 are in red and blue respectively, while the other lettering and reaction symbols on the plate are black. To keep the balance vertical the support plate push fits into a slot cut in a chipboard base measuring 370 x 150 x 28mm.

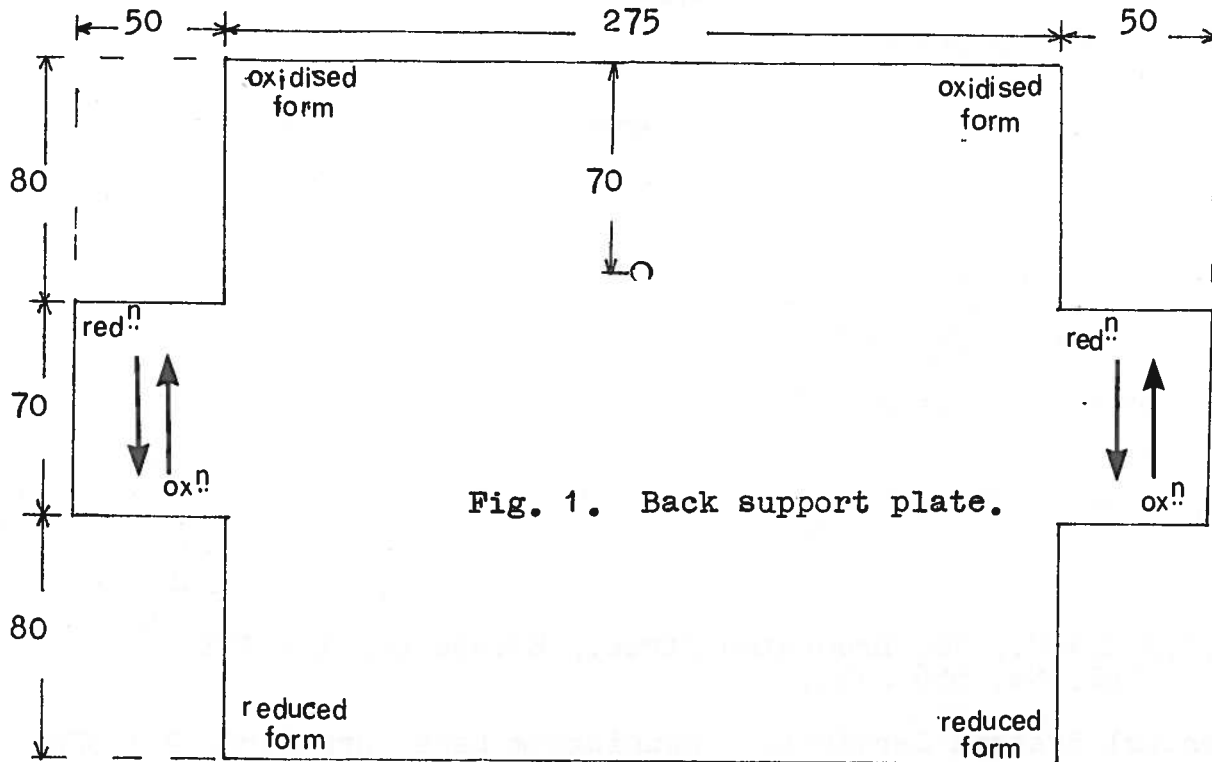

Fig. 1. Back support plate.

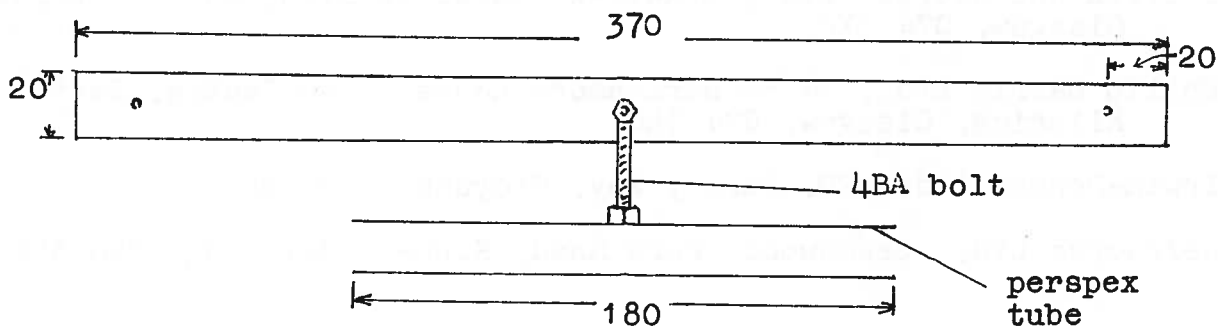

Fig. 2. Balance beam.

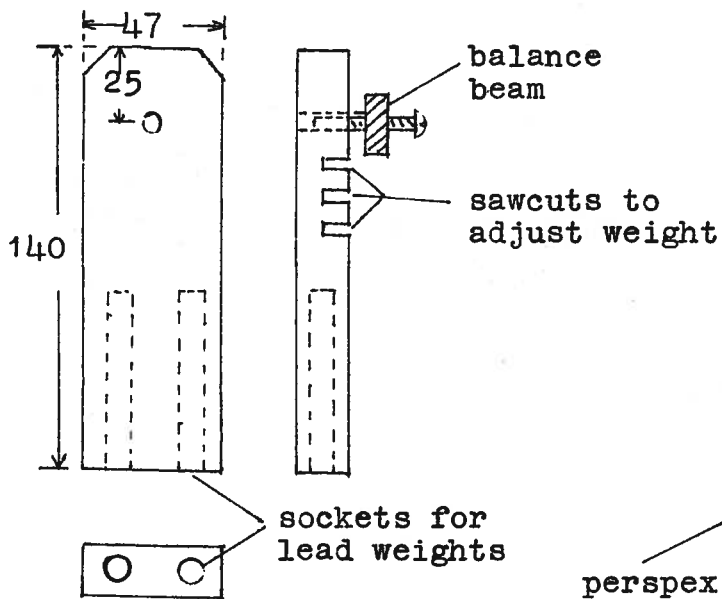

Fig. 3.

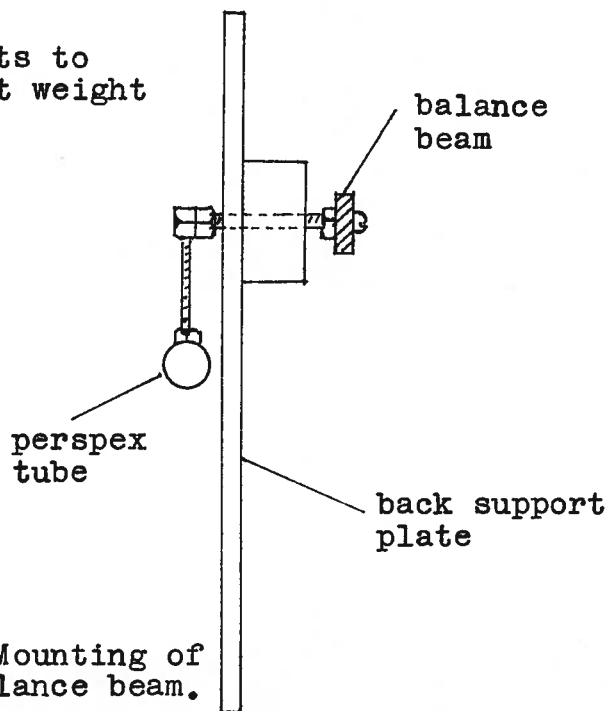

Fig. 4. Mounting of balance beam.

All dimensions in mm.

S.S.S.E.R.C., 103 Broughton Street, Edinburgh, EH1 3RZ  
Tel. No. 556 2184.

Control Systems Services, 4 Manningham Lane, Bradford, BD1 3DE.

Griffin and George Ltd., Braeview Place, Nerston, East Kilbride,  
Glasgow, G74 3XJ.

Philip Harris Ltd., 34/36 Strathmore House, Town Centre, East  
Kilbride, Glasgow, G74 1LQ.

Irwin-Desman Ltd., 294 Purley Way, Croydon, CR9 4QL.

Refracpac Ltd., Beechwood, Fore Road, Kippen, Stirling, FK8 3DT.